

Your Futaba update compatible servo programming can be updated easily online. When functions are improved, the update file can be downloaded from our website.

For more information, check out web site for FAQ regarding updating this product.

*The display screen is an example. The screen depends on the PC.

Required for update (Purchase separately)

CIU-3
(CIU-2 cannot be used.)



Y-Harness or Dual Hub Extension

Battery (for servo)

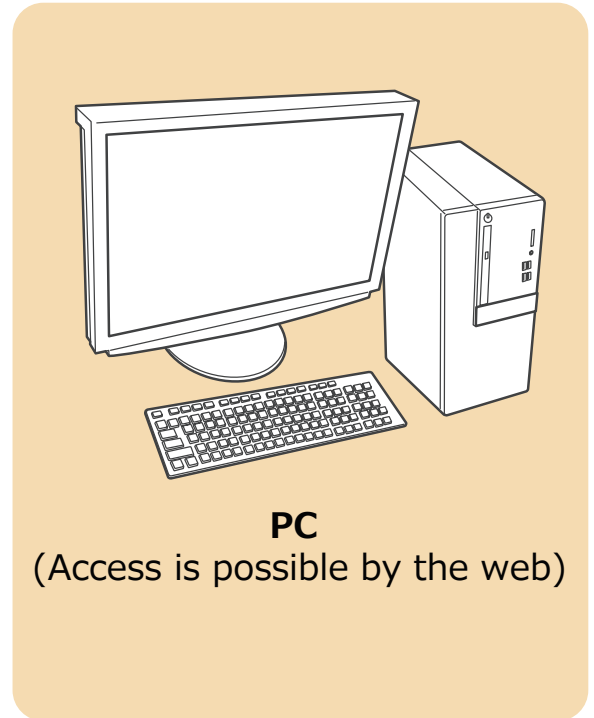
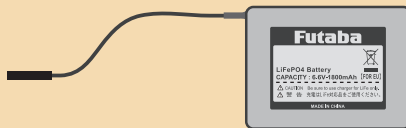

PC
(Access is possible by the web)

Preparations

1. Install the driver for the CIU-3 onto your PC.

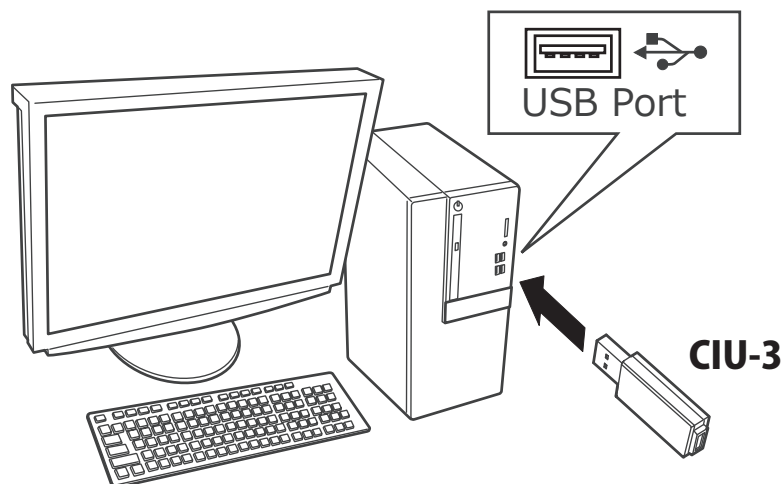

- ◆ When the **CIU-3** is first connected to the PC, once the CIU-3 is connected to the PC, download the recommended driver software Using depending on the PC, the "Found New Hardware Wizard" window appears on the screen. Click "Locate and install driver software".
- ◆ Refer to the manual of the CIU-3 for further information.

Updating procedure

1. Download the zip file of the update data from our website or your local distributor's website.

Make sure to download the same update file as your servo.

<http://www.rc.futaba.co.jp>

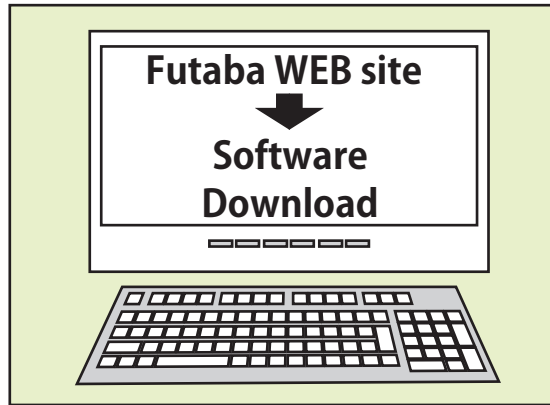

2. Extract the zip file on your computer.

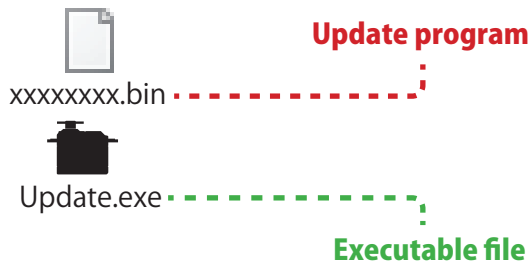

3. Connect as shown in the figure.

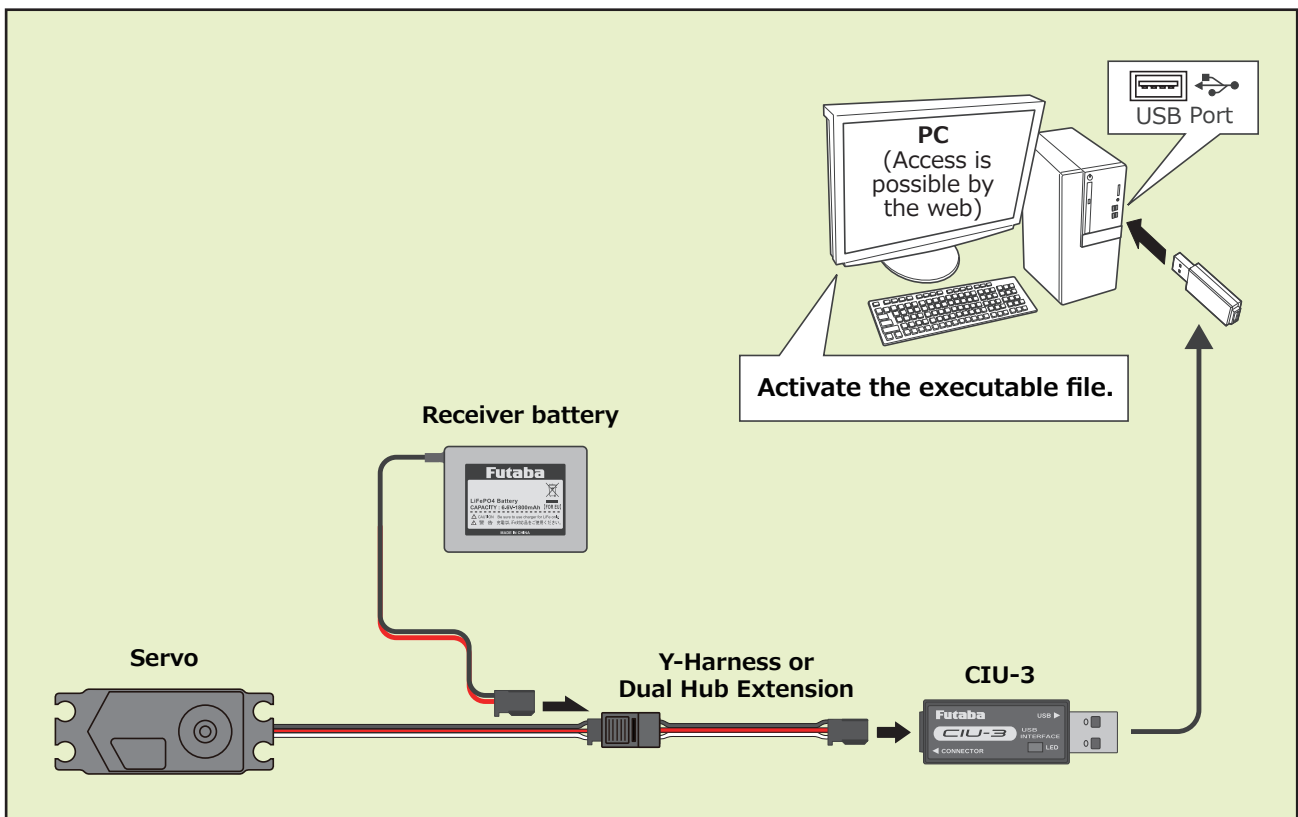

4. Operate the PC update.

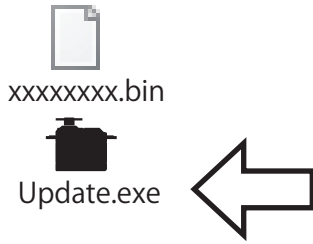

 Be sure to update using the update file for the corresponding servo.
Do not use update files for different servos!

5. Click "WRITE".

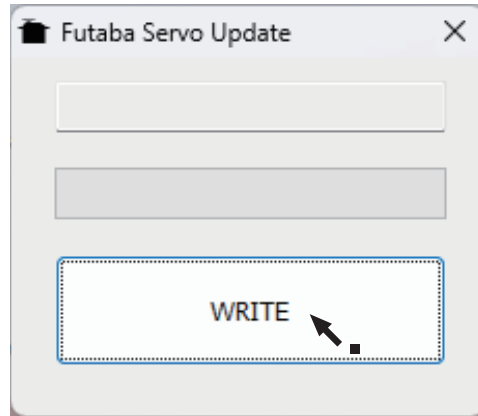

6. Click "OK".

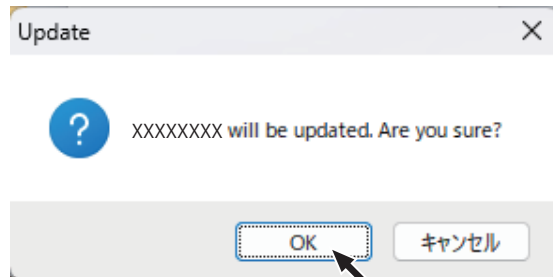

7. The servo will beep twice and the update will begin.

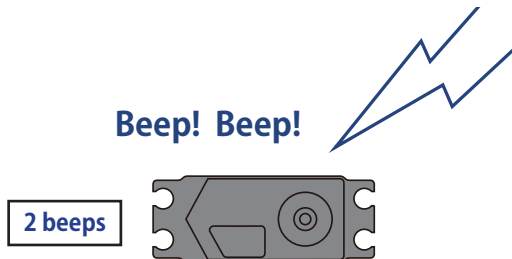

Wait for about 10 seconds.
Don't turn off the power!

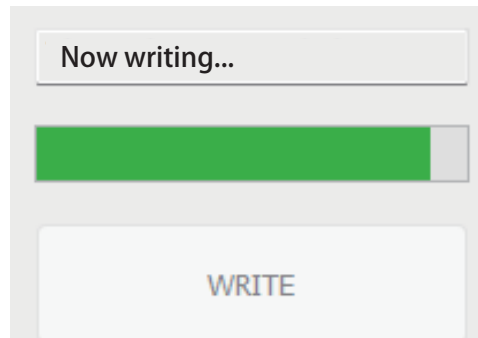

8. Update is complete when 3 beeps.

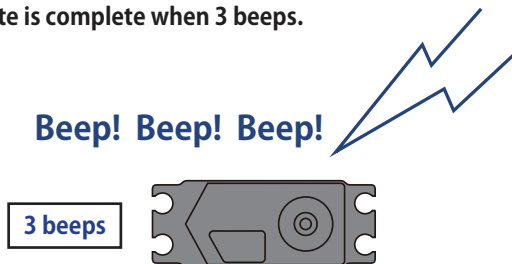

9. This completes the update process.
Click "OK" and then remove the cable.

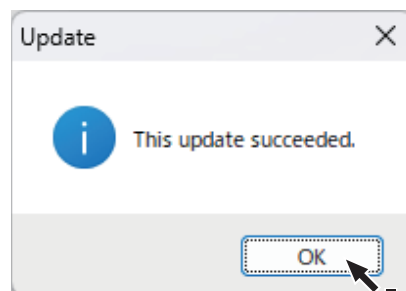

10. Be sure to check the each function before use.

V2.0 UPDATE

- Compatible with FASSTest26CH.

About FASSTest26CH S.BUS2 connect and servos :

When using the following servos with the FASSTest26CH system S.BUS2 connect , it is necessary to software version up the servos.

- HPS-A703** (Serial number less than 22597)
- HPS-AA702** (Serial number less than 20372)
- HPS-HC701** (Serial number less than 10910)
- HPS-HT700** (Serial number less than 10730)
- HPS-H701** (Serial number less than 10361)

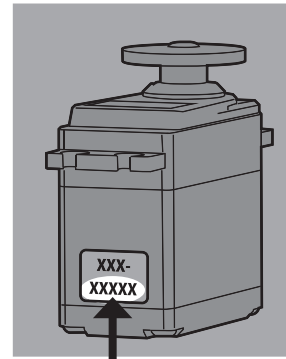

Serial number

The FASSTest 26CH mode is a new system that is ideal for those who need more channels, such as on large models. When using a conventional system (T-FHSS, FASSTest18CH, etc.), the above servos can be used as is without updating.